



Prepatch Coarse Trowel-on

TECHNICAL BULLETIN



ARMATEX 100% ACRYLIC TEXTURES [\[arma.Prepatch Coarse\]](#)

PRODUCT TYPE

100% acrylic Skim Coat.

DESCRIPTION

Armatex Pre-Patch Coarse is a 100% acrylic, water reducible thin section render and patching compound that is supplied ready for use straight from the drum, apart from the required addition of cement for exterior use.

The product can be applied by either hawk and trowel or mortar spray devices and is suitable for application to most correctly prepared mineral based construction surfaces such as flush jointed block work, Harditex, Hebel and racked brick, including, well adhered "gloss free" painted surfaces.

The product is principally used to skim entire walls and to feather edge surface misalignments in concrete prior to the application of a medium profile texture. Pre-Patch Coarse will cover surface misalignments of 2 to 4 mm and will feather down to (0.65 mm).



Astec Paints are a 100% Australian owned company committed to the research and development of technologically advanced coatings that provide premium durability against our harsh Australian conditions. Our coatings are manufactured with high regard for worker safety and environmental care and will provide you with absolute confidence in long term performance.

Pre-Patch Coarse is suitable as a flexible skim to level flush jointed block or HardiTex™ and to fill minor surface imperfections, such as blow holes in concrete panels, prior to the application of an acrylic texture.

The final result is an extremely flexible thin section mortar that is highly water and impact resistant. Pre-Patch Coarse provides a strong bond to the substrate and has minimal drying shrinkage during cure, and can be over-coated with most water based acrylic textures and topcoats.

PROPERTIES

Unlike normal render, Armatex Pre-Patch Coarse can be applied in thin sections as low as (0.65 mm) without any threat of crumbling and lack of adhesion during and after cure.

The applied finish is an extremely strong and chip resistant render, which has proven advantageous during the construction of new buildings. Square set window returns and corners dry hard and do not chip easily, which removes the threat of difficult to touch up chips caused by following trades.

Unique to Armatex are flow control and setting additives that enable a good wet edge to be maintained. In addition, provides pseudoplasticity, making the product extremely smooth but tight to apply.

Most importantly for the applicator, Armatex has undergone rigorous field and laboratory test programs that guarantee the tradesman maximum ease in fast, trouble free application that is a paramount performance requirement to achieve the uniform end result.

Unlike many available render finishes, Pre-Patch Coarse is manufactured using the highest grade of silica, quartz and marble aggregates.

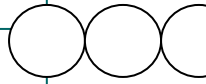

The aggregates are carefully selected and analysed to assure they are without, or have only, very low traces of iron or clay content. As a result the common threat of rust bleeding from the finish and excessive shrinkage are removed assuring the wall will remain aesthetically sound for many years to come.

DESIGNED USE

Armatex Pre-Patch Coarse is designed for the levelling of flush jointed block work, Hebel, F.C. sheeting and raked brick prior to the application of an acrylic texture.

The product is capable of covering medium surface misalignments or defects and can be applied at a thickness of up to 4 mm in one single application.

COLOUR

Armatex Pre-Patch Coarse is manufactured as a stone coloured base, however, with the addition of various coloured Portland Cements, the final colour of the render can vary from white to dark grey.

In the event a light coloured texture is to be applied over the Pre-Patch Coarse, it is advisable to use a white or off white cement.



COVERAGE RATE

1.1 m² per ltr @ average spreadable thickness = 0.9mm

16.5m² per 15 ltr drum average use (applicator and substrate dependant)

CEMENT QUANTITIES

Pre-Patch Coarse can be used on interior walls as supplied. However, requires the addition of 10% cement by weight for exterior rendering.

Up to 25% cement by weight can be added which will further thicken and tighten the mix during application. A tighter wet mix is preferred by some applicators as the higher addition of cement allows for thicker applied films, furthermore, will provide a faster cure and a harder surface than normal when dry.

DRYING TIMES

Pre-Patch Coarse will dry to touch in approximately 30 mins to 2 hrs at 25°C and 50% relative humidity depending on the applied film thickness.

The film will reach full cure in 7 days. The surface can be textured the following day in most cases, dependent upon climatic conditions and the thickness of applied film.

CLEAN UP

All equipment can be washed up in water. Do not allow waste water to enter sewers or water courses. Any spilt material should be allowed to dry and be disposed to land fill according to local regulations.

MIXING

Mixing the cement into the product can be carried out by using an electric mixer in a 15 ltr drum.

The measured amount of cement can be mixed direct into the product, however, some lumps may occur. To avoid cement lumps, add a very small amount of water to the cement first and mix to make a tight slurry. Add the slurry to the product and mix as normal. This will ensure the mix will be lump free.

THINNING

Thinning can be done with clean fresh water or Astec Summer Thinners. The amount of thinner should not exceed 1% by weight and should be determined by the applicator on the day of use, taking all climatic and evaporation factors into account.

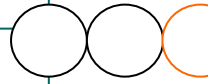

LIMITATIONS

Pre-Patch Coarse should be applied at temperatures between 10°C and 32°C. Avoid application in extreme heat and or windy conditions and always work with shaded areas out of direct sunlight. Always protect the applied product from freezing prior to cure.

During inclement weather and where you know the temperature will fall below 10°C at night, always terminate work early enough to allow sufficient time for the product to cure. In some areas this could be as early as 12 pm to 1pm.

When applying Armatex at temperatures around 10°C you must remember that in some cases the substrate temperature can be many degrees lower.

Under these circumstance it is advisable to conduct a small test patch to ensure cure will take place. In the event the product does not cure, application must be postponed until the weather is more suitable.

Pre-Patch Coarse is a water based material, therefore, should not be applied during inclement weather or when precipitation and freezing are imminent.

SURFACE PREPARATION

The surface should be clean dry and free of all surface contaminants, such as, grease, mould and **most importantly, release agents**. Remove any loose mortar splashes and cut back protruding block or tie wires. Remove any loose paint and all surface gloss from any remaining paint.

In the event a high suction wall reduces application and finishing times to less than that required. The wall can be sealed with Astec Rivett, Rapid Seal or on HardiTex™, Aggraseal just prior to application. A seal coat prior to application of the render, will slow surface suction and increase application and working times.

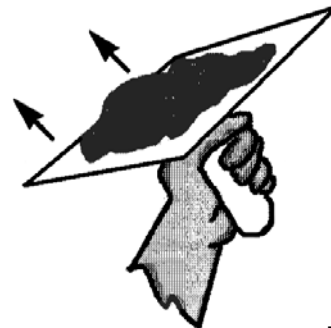

Figure 1



Figure 2



Figure 3

(diagram 1)

Contact Astec for assistance on the correct procedure for the removal of **release agents** or any other surface preparation difficulties.

EQUIPMENT REQUIRED

Pre-Patch Coarse is applied with a hawk and trowel, (**See Diagram 1**), then levelled smooth with a stainless steel trowel, (**See Diagram 3**), to achieve its final finish. (See application technique for details).

A high quality stainless steel trowel is the most suitable trowel for application and finishing of this product. It is not advisable to apply the product with a mild steel trowel as traces of iron can be left on the surface which can cause unsightly rust stains to appear. In addition, a steel trowel drags on the surface of the render more than stainless steel making application more difficult.

APPLICATION TECHNIQUE

Load a manageable amount of render to your hawk via a scoop. (**See Diagram 1, Fig 1**). Then load your trowel by moving it across your hawk starting from the edge closest to your body, while at the same time tilting the outer edge of the hawk up and toward yourself to assist in pick-up of the render. (**See Diagram 1, Fig 2 & 3**).

Transfer the render from the trowel to the wall in vertical strips starting at the top of the wall and across an area of approximately 1 metre wide. (**See Diagram 2**).

NOTE: THE AMOUNT OF AREA COVERED PRIOR TO FINISHING WILL DEPEND ON THE WET EDGE TIME THAT WILL CHANGE WITH EACH DIFFERENT SUBSTRATE AND IS HIGHLY DEPENDENT ON WEATHER CONDITIONS. DO NOT GET TOO FAR AHEAD AS LOSING THE PRODUCTS WET EDGE WILL RESULT IN A POOR FINAL APPEARANCE.

With your trowel at a 45 degree angle to the surface and using an arc motion, use even pressure to spread and smooth off the wet render. (**See Diagram 3**).



(diagram.2) transfer the Pre-patch to the wall



(diagram.3) smooth off and remove excess

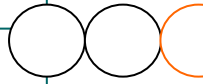

FORM MARKS IN CONCRETE

The trowel is placed across the misalignment with the front edge raised to a 45° angle. While maintaining this angle, the trowel is drawn along the section with even pressure. Form marks should be feathered at a ratio of 50mm for every 1mm of surface misalignment. (See Diagram 4 & 5).

MINOR IMPERFECTIONS

Minor surface imperfections such as; blow holes, scratches and trim back areas in concrete can be filled with a spatular or blade. (See Diagram 6).

SPECIAL CONSIDERATIONS

Careful consideration must be given to the size of the area, as the application must take place without interruptions across the entire area. In the event that the area is too large to effect uninterrupted application, the area should be architecturally broken up into more manageable sizes.

Most importantly, the applicators must consider the weather elements to ensure that the product is not applied in direct sunlight, on hot surfaces or when hot wind is present.

It is imperative that the product be applied to the entire selected area while maintaining a wet edge.

Attention to detail with on site planning and logistics, including weather, scaffolding for substrate access and the sizing of manageable areas will ensure the longest possible time is achieved to effect a uniform finish across the entire project.

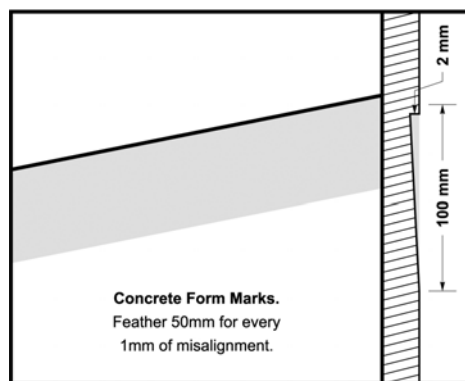

(diagram.4) feathered concrete form marks

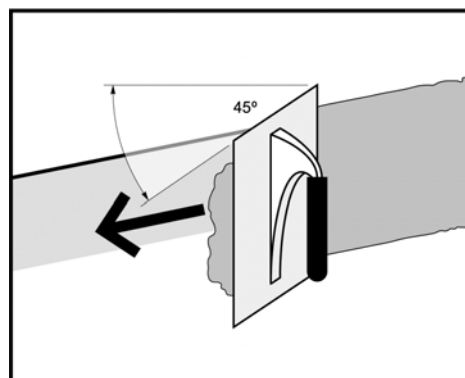

(diagram.5) applying pre-patch Coarse

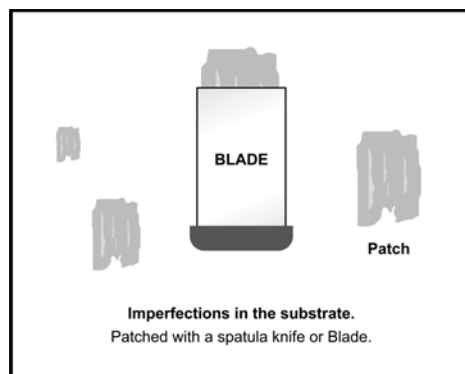

(diagram.6) patching substrate imperfections

PRODUCT DATA



ARMATEX 100% ACRYLIC TEXTURES [arma Prepatch Coarse

Gloss Level	Flat/Aggregate
Recommended Thinners	Water
Touch Dry 25 deg C, 50% RH	1 hour
Handle @ 25 deg C, 50% RH	2 hours
Dry @ 25 deg C, 50% RH	24 hours
Theoretical spread rate [@ 900 mic D.F.T.]	1.1 m ² /ltr
Abrasion Resistance	Excellent
Impact Resistance	Excellent
Solvent resistance [Full top coated system]	
Alcohol	No reaction
Salt water	No reaction
Distilled water	No reaction
Diluted Caustic Soda	No reaction
Detergent solution	No reaction
Dilute 5% mineral acid	No reaction
Weatherability [Full Top-coated system]	Excellent
Specific Gravity	1.782
Solids volume	74% V/V
P.V.C.	83% V/V
Moisture vapour transmission [Method ASTM E96-1966 Full top-coated system]	42.7g.m ² /24hrs

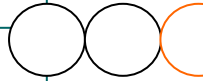

The technical data furnished herein is based upon data believed by Astec Paints to be true and accurate at the time of writing, however, no guarantee of accuracy is given or implied and is subject to change without notice.

This information is given in good faith for the assistance of users. No legal warranty expressed or implied is made as to its accuracy, completeness or otherwise.

Every person dealing with this material herein does so at their own risk absolutely and must make independent determinations of suitability and completeness from all sources to ensure their proper use.

We have no control over the condition under which these products are stored, handled or used, therefore our recommendations must not be regarded as a mounting to legal warranty or as involving any liability on us.



Astec Paints Australasia Pty. Ltd.
22-24 Pinn Street, St. Marys,
South Australia 5042
PO Box 321, Melrose Park, S.A. 5039

Web: www.astecpaints.com.au
Email: enquiries@astecpaints.com.au

Telephone: +61 8 8297 2000
Facsimile: +61 8 8297 2555

Your Nearest Astec Paints Distributor is;

Revised Edition April, 2015

Astec Paints Resellers;

Australia Wide

For a complete list of resellers,
please visit the Contact Page
of our website:

www.astecpaints.com.au/contact

Overseas

Please contact Head Office.